

MTS

- Threading from ISO M1 x 0.25 and 0-80UN.
- Working in high cutting speed.
- Short machining time.
- Low cutting forces thanks to the short profile.
- No broken taps.
- Machining of hardened materials up to 45 HRC.

Advantages

- Enables machining in deep holes.
- Same tool can produce a wide range of threads and pitches.
- Same tool can produce both External and Internal threads.
- Coolant through the flutes is very effective for deep holes.
- Spiral flutes allow smooth cutting action.
- Shorter machining time due to multi (3 to 5) flutes.
- Longer tool life due to special triple coating.

MTSB

Solid carbide thread mills with internal coolant bore and increased number of flutes for high performance, shorter cycle time and improved tool life.

MTI - For threading deep parts

FMTI

Thread mills with a large number of flutes that enables to achieve significant shorter machining time, increased productivity and high performance.

Contents:	Page:	Contents:	Page:
Product Identification	2	G 55° BSP	12
MTS	3-8	MTI	13-16
ISO	3-4	Partial Profile 60°	13
UN	5-6	Partial Profile 60° with internal coolant	14
G (55°) BSW, BSP	7	Partial Profile 55°	14
MJ	8	ISO	15
UNJ	8	UN	15
MTS Dental	9	Trapez-DIN 103	16
ISO	9	Acme	16
UN	9	FMTI Multi Flute	17
MTSB	10-12	ISO	17
ISO	11	UN	17
UN	12		

Product Identification

Mini Mill-Thread MTS Ordering Codes

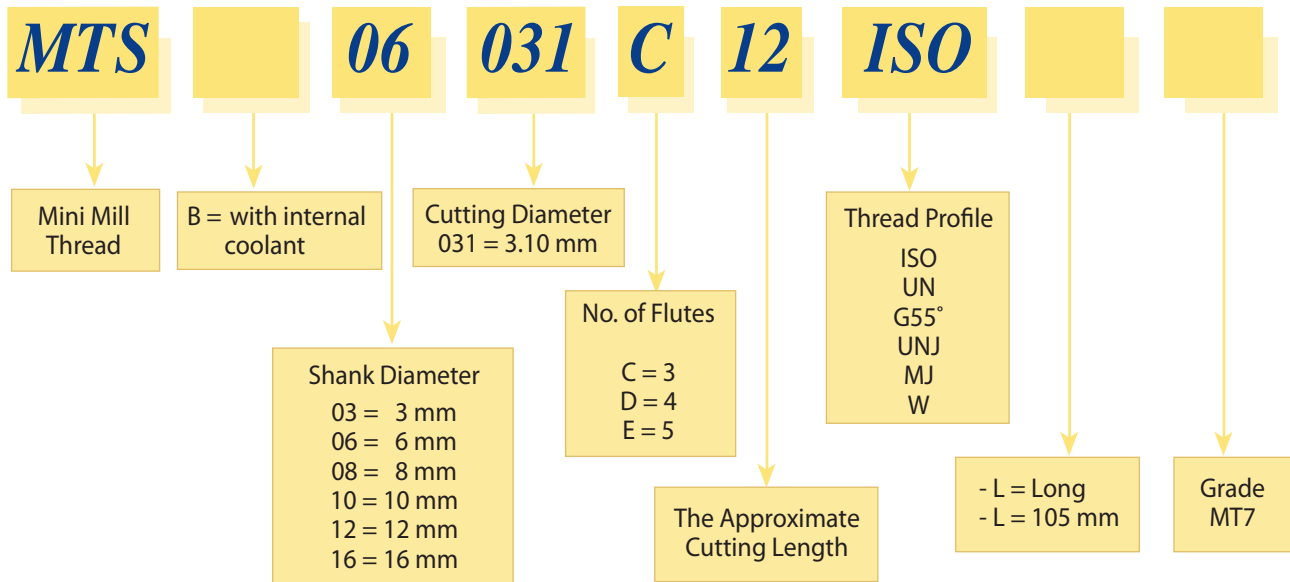

Mini Mill-Thread MTI and FMTI Ordering Codes

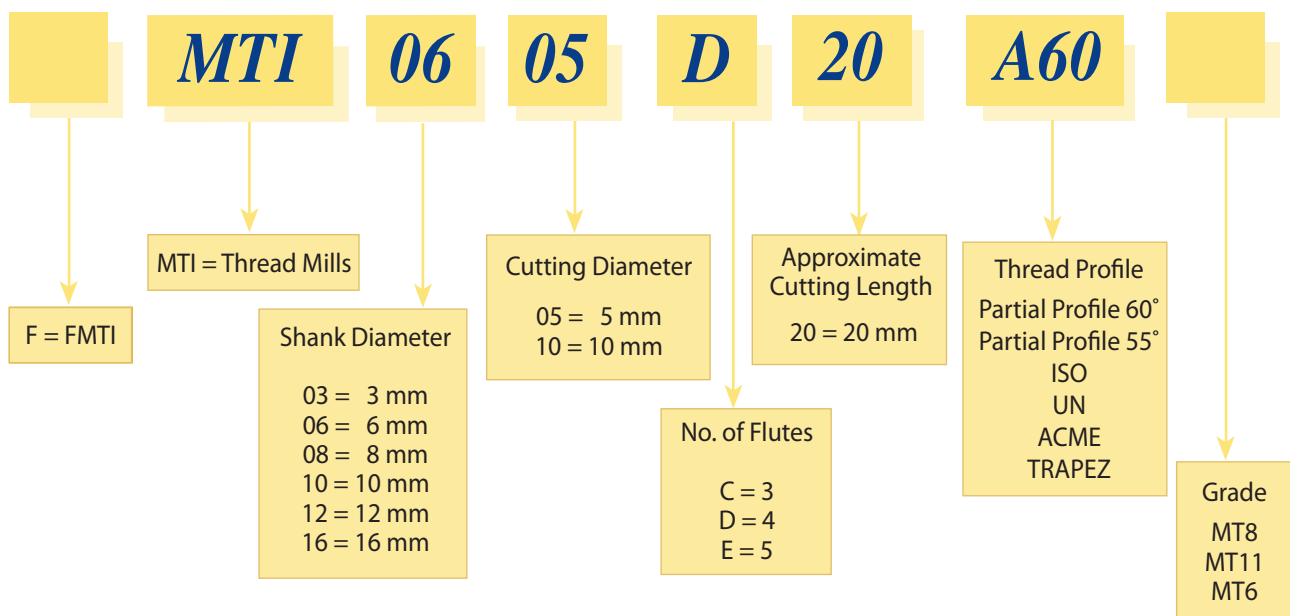

MTS



Demonstration

Carbide grade: MT7

Sub-Micron grade with Titanium Aluminum Nitride multi-layer coating (ISO K10 - K20).
To be run at medium to high cutting speeds. General purpose for all materials.

ISO

Tools for Internal Thread

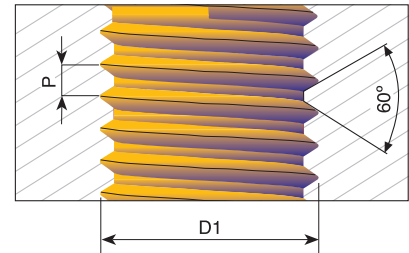
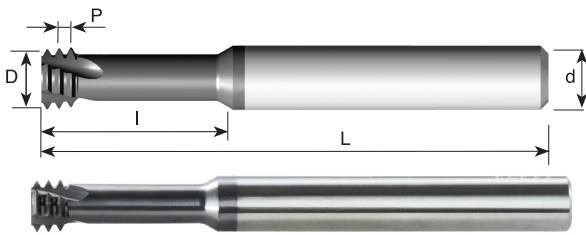

Grade	P	M	K	N	S	H
MT7	●	○	●	●	●	≤45 HRc

Pitch mm	M Coarse	M Fine	Ordering Code	d	D	No. of Flutes	I	L	Thread depth
0.25	M1, M1.1		MTS 03007 C2 0.25 ISO	3	0.72	3	2.5	39	2.5xD1
0.25	M1.2	M1.4	MTS 03009 C3 0.25 ISO	3	0.90	3	3.0	39	2xD1
0.3	M1.4		MTS 03011 C4 0.3 ISO	3	1.05	3	4.0	39	3xD1
0.35	M1.6,M1.8	M2, M2.5	MTS 03012 C5 0.35 ISO	3	1.20	3	4.8	39	3xD1
0.35	M1.6,M1.8	M2, M2.5	MTS 06012 C5 0.35 ISO-L	6	1.20	3	4.8	105	3xD1
0.35		M5, M6	MTS 06045 D14 0.35 ISO	6	4.50	4	14.5	58	3xD1
0.4	M2		MTS 06016 C4 0.4 ISO	6	1.53	3	4.5	58	2xD1
0.4	M2		MTS 06016 C4 0.4 ISO-L	6	1.53	3	4.5	105	2xD1
0.4	M2		MTS 03016 C6 0.4 ISO	3	1.53	3	6.0	39	3xD1
0.4	M2		MTS 03016 C10 0.4 ISO	3	1.53	3	10.4	39	5xD1
0.45	M2.2		MTS 06017 C5 0.45 ISO	6	1.65	3	5.0	58	2xD1
0.45	M2.2		MTS 03017 C7 0.45 ISO	3	1.65	3	7.0	39	3xD1
0.45	M2.5		MTS 0602 C5 0.45 ISO	6	1.95	3	5.5	58	2xD1
0.45	M2.5		MTS 0602 C5 0.45 ISO-L	6	1.95	3	5.5	105	2xD1
0.45	M2.5		MTS 0602 C7 0.45 ISO	6	1.95	3	7.5	58	3xD1
0.45	M2.5		MTS 0602 C8 0.45 ISO-L	6	1.95	3	8.0	105	3xD1
0.45	M2.5		MTS 0302 C10 0.45 ISO	3	1.95	3	10.5	39	4xD1
0.5	M3		MTS 06024 C6 0.5 ISO	6	2.37	3	6.5	58	2xD1
0.5	M3		MTS 06024 C6 0.5 ISO-L	6	2.37	3	6.5	105	2xD1
0.5	M3		MTS 06024 C9 0.5 ISO	6	2.37	3	9.5	58	3xD1
0.5	M3		MTS 06024 C9 0.5 ISO-L	6	2.37	3	9.5	105	3xD1
0.5	M3		MTS 03024 C12 0.5 ISO	3	2.40	3	12.5	39	4xD1
0.5	M3		MTS 03024 C15 0.5 ISO	3	2.40	3	15.5	39	5xD1
0.5		M4, M5	MTS 06034 D8 0.5 ISO	6	3.40	4	8.5	58	2xD1
0.5		M4, M5	MTS 06034 D12 0.5 ISO	6	3.40	4	12.5	58	3xD1
0.5		M6, M7	MTS 06054 D20 0.5 ISO	6	5.35	4	20.0	58	3xD1
0.6	M3.5		MTS 06028 C7 0.6 ISO	6	2.75	3	7.5	58	2xD1
0.6	M3.5		MTS 06028 C10 0.6 ISO	6	2.75	3	10.5	58	3xD1
0.7	M4		MTS 06031 C9 0.7 ISO	6	3.10	3	9.0	58	2xD1
0.7	M4		MTS 06031 C12 0.7 ISO	6	3.10	3	12.5	58	3xD1
0.7	M4		MTS 06031 C12 0.7 ISO-L	6	3.10	3	12.5	105	3xD1
0.7	M4		MTS 06031 C16 0.7 ISO	6	3.10	3	16.7	58	4xD1

● First choice

○ Alternative

ISO

Tools for Internal Thread

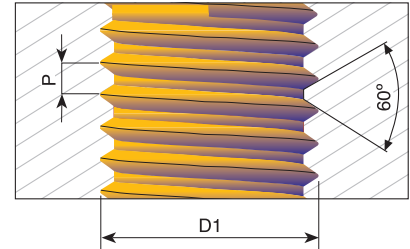
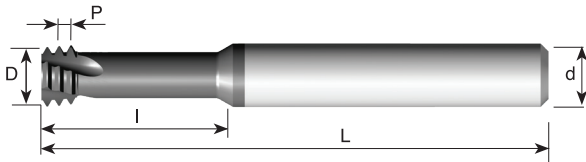

Grade	P	M	K	N	S	H
MT7	●	○	●	●	●	≤45 HRc

Pitch mm	M Coarse	M Fine	Ordering Code	d	D	No. of Flutes	I	L	Thread depth
0.75	M4.5	M5	MTS 06034 C9 0.75 ISO	6	3.40	3	9.8	58	2xD1
0.75		M6	MTS 06049 D12 0.75 ISO	6	4.90	4	12.8	58	2xD1
0.75		M10, M12	MTS 0808 D25 0.75 ISO	8	8.00	4	25.0	64	2.5xD1
0.8	M5		MTS 06038 C12 0.8 ISO	6	3.80	3	12.5	58	2xD1
0.8	M5		MTS 06038 C16 0.8 ISO	6	3.80	3	16.0	58	3xD1
0.8	M5		MTS 06038 C16 0.8 ISO-L	6	3.80	3	16.0	105	3xD1
0.8	M5		MTS 0604 C20 0.8 ISO	6	4.00	3	20.8	58	4xD1
1.0	M6	M8	MTS 06047 C14 1.0 ISO	6	4.65	3	14.0	58	2xD1
1.0	M6	M8	MTS 06047 C20 1.0 ISO	6	4.65	3	20.0	58	3xD1
1.0	M6	M8	MTS 06047 C20 1.0 ISO-L	6	4.65	3	20.0	105	3xD1
1.0	M6	M8	MTS 06048 C25 1.0 ISO	6	4.80	3	25.0	58	4xD1
1.0		M10, M12	MTS 0808 D31 1.0 ISO	8	8.00	4	31.0	64	3xD1
1.25	M8	M10, M12	MTS 0606 C18 1.25 ISO	6	6.00	3	18.0	58	2xD1
1.25	M8	M10, M12	MTS 0606 C24 1.25 ISO	6	6.00	3	24.0	58	3xD1
1.25	M8	M10, M12	MTS 0606 C24 1.25 ISO-L	6	6.00	3	24.0	105	3xD1
1.25	M8	M10, M12	MTS 08064 C33 1.25 ISO	8	6.40	3	33.5	64	4xD1
1.5	M10	M14, M16	MTS 08078 C23 1.5 ISO	8	7.80	3	23.0	64	2xD1
1.5	M10	M14, M16	MTS 08078 C31 1.5 ISO	8	7.80	3	31.5	64	3xD1
1.5	M10	M14, M16	MTS 08078 C31 1.5 ISO-L	8	7.80	3	31.5	105	3xD1
1.5	M10	M14, M16	MTS 0808 C41 1.5 ISO	8	8.00	3	41.5	76	4xD1
1.75	M12		MTS 1009 C26 1.75 ISO	10	9.00	3	26.0	73	2xD1
1.75	M12		MTS 1009 C37 1.75 ISO	10	9.00	3	37.8	73	3xD1
2.0	M14	M17	MTS 1010 D30 2.0 ISO	10	10.00	4	30.0	73	2xD1
2.0	M16	M18, M20	MTS 12118 D35 2.0 ISO	12	11.80	4	35.0	84	2xD1
2.0	M16	M18, M20	MTS 12118 D50 2.0 ISO	12	11.80	4	50.0	105	3xD1
2.5	M20		MTS 1615 E43 2.5 ISO	16	15.00	5	43.0	105	2xD1

Order example: MTS 06047 C14 1.0 ISO MT7

● First choice

○ Alternative

UN

Tools for Internal Thread

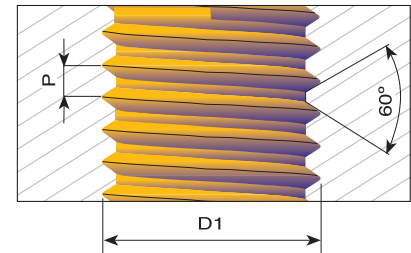
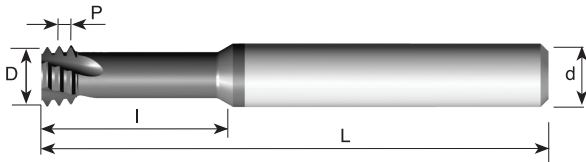

Grade	P	M	K	N	S	H
MT7	●	○	●	●	●	≤45 HRc

Pitch TPI	UNC	UNF	Ordering Code	d	D	No. of Flutes	l	L	Thread depth
80		0	MTS 06012 C4 80 UN	6	1.15	3	4.0	58	3xD1
80		0	MTS 03012 C8 80 UN	3	1.15	3	8.0	39	5xD1
72		1	MTS 06014 C3 72 UN	6	1.45	3	3.7	58	2xD1
72		1	MTS 03015 C6 72 UN	3	1.45	3	6.0	39	3xD1
64	1	2	MTS 06014 C3 64 UN	6	1.40	3	3.8	58	2xD1
56	2	3	MTS 03016 C4 56 UN	3	1.65	3	4.4	39	2xD1
56	2	3	MTS 06016 C4 56 UN	6	1.65	3	4.4	58	2xD1
56	2	3	MTS 03016 C6 56 UN	3	1.65	3	6.6	39	3xD1
56	2	3	MTS 06016 C6 56 UN	6	1.65	3	6.6	58	3xD1
56	2	3	MTS 06016 C6 56 UN-L	6	1.65	3	6.6	105	3xD1
56	2	3	MTS 03016 C9 56 UN	3	1.65	3	9.2	39	4xD1
56	2	3	MTS 03016 C11 56 UN	3	1.65	3	11.4	39	5xD1
48	3	4	MTS 06019 C5 48 UN	6	1.90	3	5.2	58	2xD1
40	4		MTS 06021 C6 40 UN	6	2.10	3	6.3	58	2xD1
40	4		MTS 06021 C6 40 UN-L	6	2.10	3	6.3	105	2xD1
40	4		MTS 03021 C8 40 UN	3	2.10	3	8.0	39	3xD1
40	4		MTS 06021 C8 40 UN	6	2.10	3	8.0	58	3xD1
40	4		MTS 06021 C8 40 UN-L	6	2.10	3	8.0	105	3xD1
40	4		MTS 03021 C12 40 UN	3	2.10	3	12.0	39	4xD1
40	5	6	MTS 06024 C7 40 UN	6	2.45	3	7.0	58	2xD1
40	5	6	MTS 06024 C9 40 UN	6	2.45	3	9.6	58	3xD1
36		8	MTS 06033 C9 36 UN	6	3.30	3	9.0	58	2xD1
32	6		MTS 06025 C7 32 UN	6	2.55	3	7.1	58	2xD1
32	6		MTS 06025 C7 32 UN-L	6	2.55	3	7.1	105	2xD1
32	6		MTS 03025 C10 32 UN	3	2.55	3	10.5	39	3xD1
32	6		MTS 06025 C10 32 UN	6	2.55	3	10.5	58	3xD1
32	6		MTS 06025 C10 32 UN-L	6	2.55	3	10.5	105	3xD1
32	6		MTS 03025 C14 32 UN	3	2.55	3	14.8	39	4xD1
32	8		MTS 06032 C9 32 UN	6	3.20	3	9.5	58	2xD1
32	8		MTS 06032 C9 32 UN-L	6	3.20	3	9.5	105	2xD1
32	8		MTS 06032 C12 32 UN	6	3.20	3	12.5	58	3xD1
32	8		MTS 06032 C12 32 UN-L	6	3.20	3	12.5	105	3xD1
32	8		MTS 06032 C17 32 UN	6	3.20	3	17.5	58	4xD1
32		10	MTS 06037 C10 32 UN	6	3.70	3	10.5	58	2xD1
32		10	MTS 06037 C15 32 UN	6	3.70	3	15.0	58	3xD1
32		10	MTS 06037 C15 32 UN-L	6	3.70	3	15.0	105	3xD1
32		10	MTS 06037 C20 32 UN	6	3.70	3	20.0	58	4xD1
28		12	MTS 06042 C11 28 UN	6	4.20	3	11.0	58	2xD1

Order example: [MTS 06021 C6 40 UN MT7](#)

● First choice

○ Alternative

UN

Tools for Internal Thread

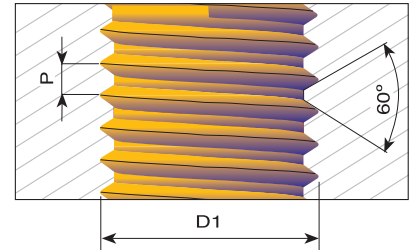
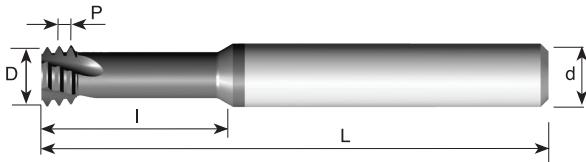

Grade	P	M	K	N	S	H
MT7	●	○	●	●	●	≤45 HRc

Pitch TPI	UNC	UNF	Ordering Code	d	D	No. of Flutes	I	L	Thread depth
28		1/4	MTS 0605 C14 28 UN	6	5.00	3	14.5	58	2xD1
28		1/4	MTS 0605 C19 28 UN	6	5.00	3	19.0	58	3xD1
28		1/4	MTS 0605 C19 28 UN-L	6	5.00	3	19.0	105	3xD1
24	10,12		MTS 06035 C10 24 UN	6	3.50	3	10.6	58	2xD1
24	10,12		MTS 06035 C15 24 UN	6	3.50	3	15.5	58	3xD1
24	10,12		MTS 06035 C15 24 UN-L	6	3.50	3	15.5	105	3xD1
24		5/16, 3/8	MTS 08066 C17 24 UN	8	6.60	3	17.0	64	2xD1
24		5/16, 3/8	MTS 08066 C24 24 UN	8	6.60	3	24.0	64	3xD1
20	1/4		MTS 06047 C14 20 UN	6	4.75	3	14.0	58	2xD1
20	1/4		MTS 06047 C14 20 UN-L	6	4.75	3	14.0	105	2xD1
20	1/4		MTS 06047 C19 20 UN	6	4.75	3	19.0	58	3xD1
20	1/4		MTS 06047 C19 20 UN-L	6	4.75	3	19.0	105	3xD1
20		7/16	MTS 0808 C25 20 UN	8	8.00	3	25.0	64	2xD1
20		7/16	MTS 0808 C34 20 UN	8	8.00	3	34.6	64	3xD1
18	5/16		MTS 0606 C17 18 UN	6	6.00	3	17.0	58	2xD1
18	5/16		MTS 0606 C23 18 UN	6	6.00	3	23.0	58	3xD1
18		5/8	MTS 1212 D35 18 UN	12	12.00	4	35.0	84	2xD1
18		5/8	MTS 1212 D49 18 UN	12	12.00	4	49.0	105	3xD1
16	3/8		MTS 08067 C22 16 UN	8	6.70	3	22.0	64	2xD1
16	3/8		MTS 08067 C30 16 UN	8	6.70	3	30.2	64	3xD1
14	7/16		MTS 08077 C25 14 UN	8	7.70	3	25.0	64	2xD1
14	7/16		MTS 08077 C35 14 UN	8	7.70	3	35.2	64	3xD1
13	1/2		MTS 10092 C27 13 UN	10	9.20	3	27.5	73	2xD1
13	1/2		MTS 10092 C40 13 UN	10	9.20	3	40.1	73	3xD1
12	9/16		MTS 12105 C31 12 UN	12	10.50	3	31.5	84	2xD1
12	9/16		MTS 12105 C45 12 UN	12	10.50	3	45.0	105	3xD1
11	5/8		MTS 12114 C34 11 UN	12	11.40	3	34.5	84	2xD1
11	5/8		MTS 12114 C50 11 UN	12	11.40	3	50.0	105	3xD1
10	3/4		MTS 16144 D41 10 UN	16	14.40	4	41.5	105	2xD1
10	3/4		MTS 16144 D59 10 UN	16	14.40	4	59.7	105	3xD1

Order example: MTS 06035 C10 24 UN MT7

● First choice

○ Alternative

G (55°) BSW, BSP

Same Tool for Internal and External Thread

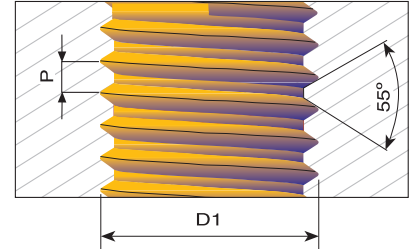
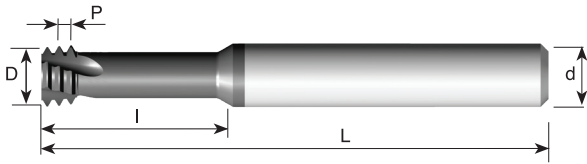

Grade	P	M	K	N	S	H
MT7	●	○	●	●	●	≤45 HRc

Pitch TPI	Standard	Ordering Code	d	D	No. of Flutes	I	L	Thread depth
28	G 1/8	MTS 08078 C19 28 W	8	7.8	3	19.5	64	2xD1
19	G 1/4 - 3/8	MTS 1010 D30 19 W	10	10.0	4	30.0	73	2xD1
14	G 1/2 - 7/8	MTS 1212 D37 14 W	12	12.0	4	37.0	84	2xD1
11	G ≥ 1	MTS 1616 D44 11 W	16	16.0	4	44.0	105	2xD1

Order example: MTS 1212 D37 14 W MT7

● First choice ○ Alternative

Carbide grade: MT8

Sub Micron grade with advanced PVD triple coating (ISO K10-K20).

Extremely high heat resistance and smooth cutting operation for high performance in normal and general machining conditions on all materials.

MJ With internal coolant through the flutes

Tools for Internal Thread

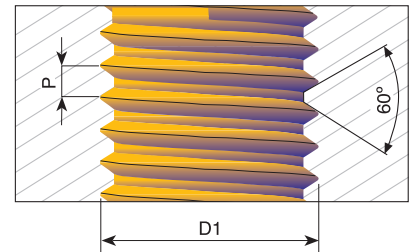
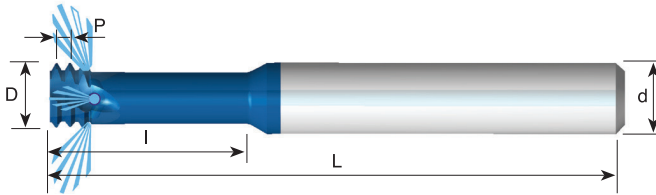

Grade	P	M	K	N	S	H
MT8	●	●	●	○	●	≤52 HRc

Pitch TPI	D1	Ordering Code	d	D	No. of Flutes	I	L	Thread depth
0.5	MJ3	*MTS 03024 C7 0.5 MJ	3	2.40	3	7.5	38	2.5xD1
0.7	MJ4	*MTS 06032 C10 0.7 MJ	6	3.20	3	10.0	58	2.5xD1
0.8	MJ5	*MTS 06039 C12 0.8 MJ	6	3.90	3	12.5	58	2.5xD1
1.0	MJ6	*MTS 06048 C15 1.0 MJ	6	4.80	3	15.0	58	2.5xD1
1.25	MJ8	MTS 08061 C20 1.25 MJ	8	6.10	3	20.0	64	2.5xD1
1.5	MJ10	MTS 0808 C25 1.5 MJ	8	8.00	3	25.5	64	2.5xD1
1.75	MJ12	MTS 10092 C30 1.75 MJ	10	9.20	3	30.0	73	2.5xD1
2.0	MJ14, MJ16	MTS 1010 C35 2.0 MJ	10	10.00	3	35.0	73	2.5xD1

* Cutters without coolant

Order example: MTS 06048 C15 1.0 MJ MT8

UNJ With internal coolant through the flutes

Tools for Internal Thread

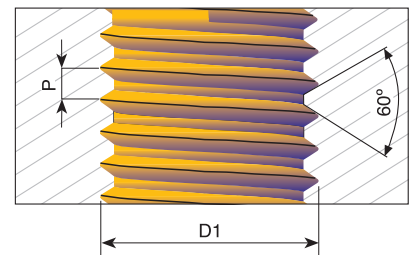
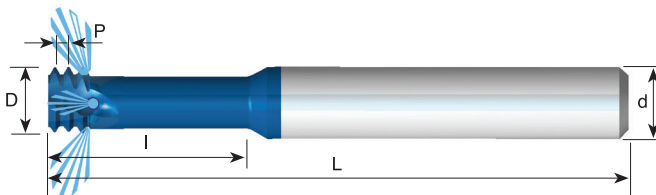

Grade	P	M	K	N	S	H
MT8	●	●	●	○	●	≤52 HRc

Pitch TPI	UNJC	UNJF	Ordering Code	d	D	No. of Flutes	I	L	Thread depth
32	6		*MTS 06025 C7 32 UNJ	6	2.55	3	7.1	58	2.5xD1
32	8	10	*MTS 06033 C10 32 UNJ	6	3.30	3	10.5	58	2.5xD1
28		1/4	MTS 08051 C16 28 UNJ	8	5.10	3	16.0	64	2.5xD1
24		5/16, 3/8	MTS 08067 C20 24 UNJ	8	6.70	3	20.0	64	2.5xD1
20	1/4		*MTS 06049 C16 20 UNJ	6	4.90	3	16.0	58	2.5xD1
20		7/16	MTS 0808 C28 20 UNJ	8	8.00	3	28.0	64	2.5xD1
18	5/16	9/16	MTS 08061 C20 18 UNJ	8	6.15	3	20.0	64	2.5xD1
16	3/8		MTS 08069 C24 16 UNJ	8	6.90	3	24.0	64	2.5xD1
14	7/16		MTS 08079 C25 14 UNJ	8	7.90	3	25.0	64	2.5xD1
13	1/2		MTS 10094 C27 13 UNJ	10	9.40	3	27.5	73	2.5xD1

* Cutters without coolant

Order example: MTS 06049 C16 20 UNJ MT8

● First choice

○ Alternative

MTS Dental

Thread Mills for the Dental Implants Industry

Specially designed geometry with long overhang providing improved machining and very high thread accuracy along with extended tool life.

Carbide grade: MT11 Ultra-fine Sub-micron grade with advanced PVD triple blue coating.

ISO

Tools for Internal Thread

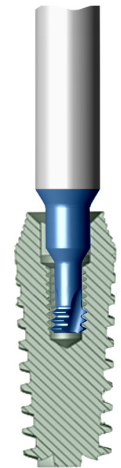
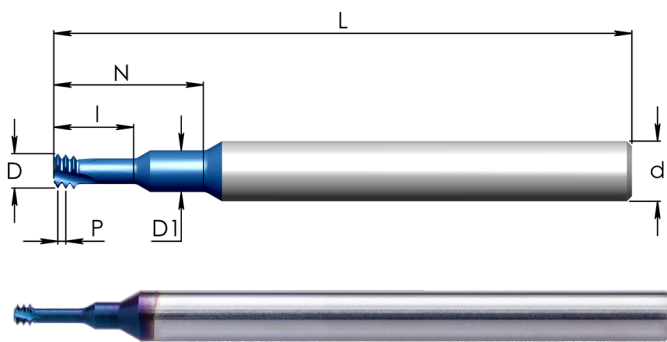

Grade	P	M	K	N	S	H
MT11	●	●	●	○	●	≤62 HRc

Pitch mm	M Coarse	Ordering Code	d	D	D1	No. of Flutes	I	N	L
0.25	M1.2	MTS 03009 C3 0.25 ISO-N4	3	0.90	1.25	3	3.0	4.7	39
0.3	M1.4	MTS 03011 C4 0.3 ISO-N7	3	1.05	1.40	3	4.0	7.2	39
0.35	M1.6,M1.8	MTS 03012 C5 0.35 ISO-N8	3	1.20	1.40	3	4.8	8.6	39
0.4	M2	MTS 03016 C4 0.4 ISO-N8	3	1.53	1.90	3	4.6	8.6	39

Order example: MTS 03011 C4 0.3 ISO-N7 MT11

UN

Tools for Internal Thread

Grade	P	M	K	N	S	H
MT11	●	●	●	○	●	≤62 HRc

Pitch TPI	UNF	Ordering Code	d	D	D1	No. of Flutes	I	N	L
80	0	MTS 03012 C3 80 UN-N5	3	1.15	1.35	3	3.1	5.6	39
72	1	MTS 03015 C4 72 UN-N5	3	1.45	1.65	3	3.7	5.9	39
72	1	MTS 03015 C4 72 UN-N10	3	1.45	1.65	3	3.7	10.0	39
72	1	MTS 03015 C4 72 UN-N15	3	1.45	1.65	3	3.7	15.0	39

Order example: MTS 03012 C3 80 UN-N5 MT11

MTSB type



An innovative solid carbide thread mill with internal coolant bore and increased number of flutes.

The coolant bore provides high coolant pressure through the tool into the application pre-hole and washes the chips away during the threading cycle.

The coolant liquid also cools the tool cutting edge very efficiently.



Demonstration

Excellent solution for:

- Small and deep threads.
- Thread milling operations on horizontal machining centers, where chips are concentrated at the bottom of the thread and external coolant can't wash the chips away.
- Complicated applications where external coolant is inefficient or can't reach the machined area.
- Case where the tool collet is close to the application pre-hole and blocks the external coolant.

Can also be used in any other thread milling operation (blind or through hole) that requires improved performance with high thread quality.

Features:

- Increased number of flutes for high performance, shorter cycle time and improved tool life.
- Working at high machining parameters (increasing productivity).
- Advanced PVD triple coating.
- Threads size: M1.2 up to M8
0-80 up to 12-24UNC

Carbide grade: MT7

Our MT7 sub-micron grade with its advanced PVD triple coating provides extremely high heat resistance along with smooth cutting action, delivering high performance under normal machining conditions.

MTSB

With Internal Coolant and Multi Flute

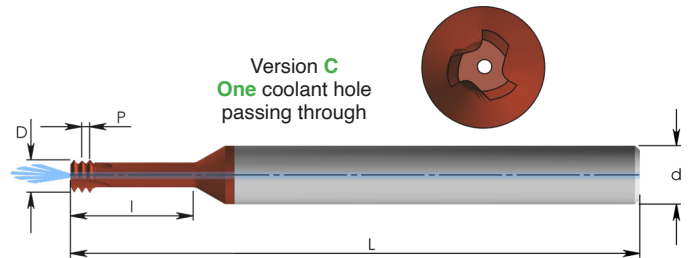
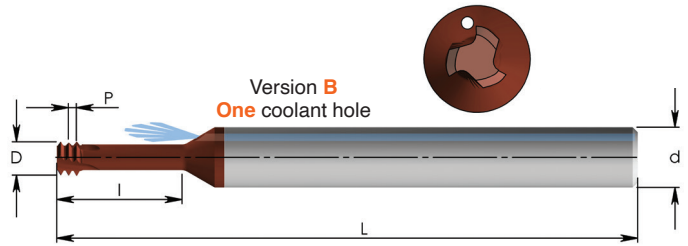
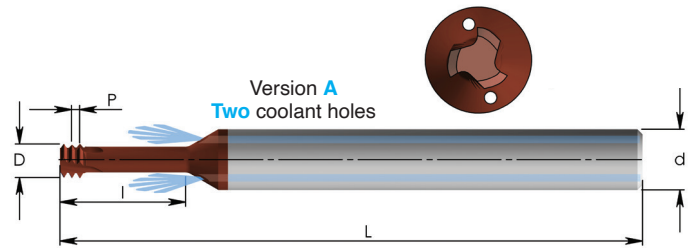

ISO

Tools for Internal Thread

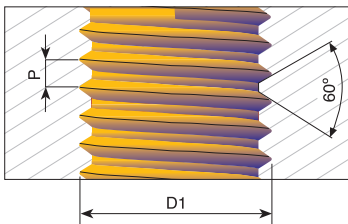

Grade	P	M	K	N	S	H
MT7	●	●	●	●	●	≤45 HRC

Pitch mm	M Coarse	M Fine	Ordering Code	d	D	No. of Flutes	I	L	Thread Depth	Version
0.25	M1.2	M1.4	MTSB 06009 C2 0.25 ISO	6	0.90	3	2.7	58	2xD1	A
0.3	M1.4		MTSB 06011 C4 0.3 ISO	6	1.05	3	4.5	58	3xD1	A
0.35	M1.6	M2	MTSB 06012 C5 0.35 ISO	6	1.20	3	5.2	58	3xD1	A
0.4	M2		MTSB 06016 C4 0.4 ISO	6	1.55	3	4.4	58	2xD1	A
0.4	M2		MTSB 06016 C6 0.4 ISO	6	1.55	3	6.4	58	3xD1	A
0.45	M2.5		MTSB 0602 D5 0.45 ISO	6	1.95	4	5.5	58	2xD1	A
0.45	M2.5		MTSB 0602 D7 0.45 ISO	6	1.95	4	7.9	58	3xD1	A
0.5	M3		MTSB 06024 D6 0.5 ISO	6	2.40	4	6.5	58	2xD1	A
0.5	M3		MTSB 06024 D9 0.5 ISO	6	2.40	4	9.5	58	3xD1	A
0.6	M3.5		MTSB 06028 D7 0.6 ISO	6	2.80	4	7.6	58	2xD1	A
0.7	M4		MTSB 06032 D8 0.7 ISO	6	3.20	4	8.7	58	2xD1	B
0.7	M4		MTSB 06032 D12 0.7 ISO	6	3.20	4	12.7	58	3xD1	B
0.8	M5		MTSB 06038 D10 0.8 ISO	6	3.80	4	10.8	58	2xD1	B
0.8	M5		MTSB 06038 D15 0.8 ISO	6	3.80	4	15.8	58	3xD1	B
1.0	M6	M8	MTSB 08048 D13 1.0 ISO	8	4.80	4	13.0	64	2xD1	B
1.0	M6	M8	MTSB 08048 D19 1.0 ISO	8	4.80	4	19.0	64	3xD1	B
1.25	M8	M10	MTSB 0606 D25 1.25 ISO	10	6.00	4	25.3	58	3xD1	C
1.5	M10		MTSB 0808 E31 1.5 ISO	8	8.00	5	31.5	64	3xD1	C
1.75	M12		MTSB 10095 E37 1.75 ISO	10	9.50	5	37.8	73	3xD1	C
2.0	M16	M17	MTSB 1212 E50 2.0 ISO	12	12.00	5	50.0	105	3xD1	C

Order example: MTSB 1212 E50 2.0 ISO MT7

● First choice ○ Alternative

UN

Tools for Internal Thread

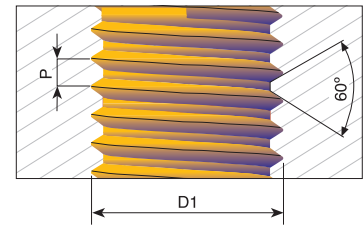

Grade	P	M	K	N	S	H
MT7	●	●	●	●	●	≤45 HRc

Pitch TPI	UNC	UNF	Ordering Code	d	D	No. of Flutes	I	L	Thread Depth	Version
80		0	MTSB 06012 C4 80 UN	6	1.15	3	4.9	58	3xD1	A
72		1	MTSB 06014 C5 72 UN	6	1.45	3	5.9	58	3xD1	A
56	2	3	MTSB 06016 C4 56 UN	6	1.65	3	4.8	58	2xD1	A
56	2	3	MTSB 06016 C7 56 UN	6	1.65	3	7.0	58	3xD1	A
48	3	4	MTSB 06019 D5 48 UN	6	1.90	4	5.6	58	2xD1	A
40	4		MTSB 06021 D6 40 UN	6	2.10	4	6.3	58	2xD1	A
40	4		MTSB 06021 D9 40 UN	6	2.10	4	9.2	58	3xD1	A
40	4		MTSB 06021 D12 40 UN	6	2.10	4	12.0	58	4xD1	A
40	5	6	MTSB 06024 D7 40 UN	6	2.45	4	7.0	58	2xD1	A
32	6		MTSB 06025 D7 32 UN	6	2.55	4	7.8	58	2xD1	A
32	6		MTSB 06025 D11 32 UN	6	2.55	4	11.3	58	3xD1	A
32	8		MTSB 06032 D9 32 UN	6	3.20	4	9.1	58	2xD1	B
32	8		MTSB 06032 D13 32 UN	6	3.20	4	13.3	58	3xD1	B
32		10	MTSB 06037 D10 32 UN	6	3.70	4	10.5	58	2xD1	B
32		10	MTSB 06037 D15 32 UN	6	3.70	4	15.3	58	3xD1	B
28		1/4	MTSB 06052 D20 28 UN	6	5.20	4	20.0	58	3xD1	C
24	10,12		MTSB 06035 D10 24 UN	6	3.50	4	10.7	58	2xD1	B
24	10,12		MTSB 06035 D15 24 UN	6	3.50	4	15.5	58	3xD1	B
24		5/16, 3/8	MTSB 08066 D24 24 UN	8	6.60	4	24.9	64	3xD1	C
20		7/16, 1/2	MTSB 10092 E34 20 UN	10	9.20	5	34.6	73	3xD1	C

Order example: MTSB 06032 D13 32 UN MT7

G55° BSP

Tools for Internal and External Thread

Grade	P	M	K	N	S	H
MT7	●	●	●	●	●	≤45 HRc

Pitch TPI	Standard	Ordering Code	d	D	No. of Flutes	I	L	Thread depth	Version
28	G1/8	MTSB 0808 E20 28W	8	8.00	5	20.4	64	2xD1	C
19	G1/4-3/8	MTSB 1010 E27 19W	10	10.00	5	27.7	73	2xD1	C
14	G1/2-7/8	MTSB 1212 E43 14W	12	12.00	5	43.7	84	2xD1	C

● First choice ○ Alternative

MTI For Threading Deep Parts

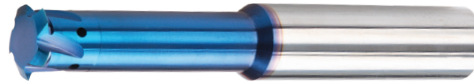

Demonstration

Low cutting forces thanks to the short profile

Carbide grade: **MT11** Ultra-fine Sub-Micron grade with advanced PVD triple blue coating.
MT8 Sub-Micron grade with advanced PVD triple coating (ISO K10-K20).
 Extremely high heat resistance and smooth cutting operation for high performance in normal and general machining conditions on all materials.

MTI Partial Profile 60° Same Tool for Internal and External Thread

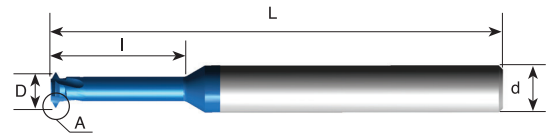
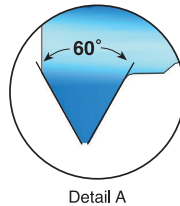

Grade	P	M	K	N	S	H
MT11	●	●	●	○	●	≤62 HRc

Pitch mm	Pitch TPI	M Coarse	M Fine	UN, UNC, UNS UNF, UNEF	Ordering Code	d mm	D	No. of Flutes	I	L
0.25-0.35	100-72	M1.6 x 0.35	M1.6 x 0.25 M1.8 x 0.25 M2 x 0.25	0-80 UNF	MTI 03012 C3 A60	3	1.15	3	3.1	39
0.35-0.45	72-56	M2 x 0.4 M2.2 x 0.45	M2 x 0.35 M2.2 x 0.35	1-64 UNC, 1-72 UNF, 2-56 UNC, 2-64 UNF	MTI 03014 C4 A60	3	1.40	3	3.7	39
0.35-0.5	72-48		M4.5 x 0.35 M5 x 0.35 M5.5 x 0.35 M6.0 x 0.35 M5 x 0.5 M6 x 0.5	10-56 UNS, 10-48 UNS, 12-56 UNS, 12-48 UNS	MTI 0604 C15 A60	6	4.00	3	15.0	58
0.35-0.6	72-40	M2.5 x 0.45	M2.5 x 0.35 M3 x 0.35	3-48 UNC, 3-56 UNF, 4-40 UNC, 4-48 UNF	MTI 03019 C5 A60	3	1.90	3	5.2	39
0.5-0.8	48-32	M3 x 0.5 M3.5 x 0.6	M3.5 x 0.5	5-40 UNC, 5-44 UNF, 6-32 UNC, 6-40 UNF	MTI 03024 C7 A60	3	2.45	3	7.0	39
0.5-1.0	48-24	M4 x 0.7 M4.5 x 0.75	M4 x 0.5	8-32 UNC, 8-36 UNF, 10-24 UNC, 10-28 UNS, 10-32 UNF	MTI 06032 C9 A60	6	3.20	3	9.5	58
0.5-1.0	48-24	M5 x 0.8 M6 x 1.0	M5 x 0.5 M5.5 x 0.5 M5 x 0.75	10-36 UNS, 10-40 UNS, 10-48 UNS, 12-24 UNC, 12-28 UNF	MTI 0604 C12 A60	6	4.00	3	12.5	58

Order example: MTI 03024 C7 A60 MT11

● First choice ○ Alternative

Partial Profile 60° With internal coolant through the flutes

Same Tool for Internal
and External Thread

For threading deep parts

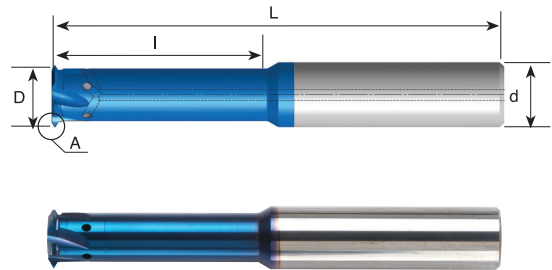
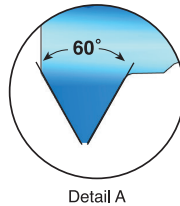

Grade	P	M	K	N	S	H
MT8	●	●	●	○	●	≤52 HRc

Pitch mm	Pitch TPI	Thread Dia. (mm)	Ordering Code	d	D	No. of Flutes	I	L
Int. 0.5 - 0.8 Ex. 0.4 - 0.8	56-28 64-32	∅ ≥ 6	MTI 0605 D20 A60	6	5.0	4	20	58
		∅ ≥ 9	MTI 0808 D28 A60	8	8.0	4	28	64
		∅ ≥ 13	MTI 1212 E38 A60	12	12.0	5	38	84
Int. 1.0 - 1.75 Ex. 0.8 - 1.5	28-14 32-16	∅ ≥ 10	MTI 0808 D30 A60	8	8.0	4	30	64
		∅ ≥ 12	MTI 1010 D35 A60	10	10.0	4	35	73
		∅ ≥ 14	MTI 1212 E39 A60	12	12.0	5	39	84
Int. 2.0 - 3.0 Ex. 1.75-2.5	13- 8 15-10	∅ ≥ 16	MTI 1212 E40 A60	12	12.0	5	40	84
		∅ ≥ 18	MTI 1614 E45 A60	16	14.0	5	45	101
		∅ ≥ 20	MTI 1616 E50 A60	16	16.0	5	50	101

Order example: MTI 0808 D28 A60 MT8

Partial Profile 55°

Same Tool for Internal and External Thread

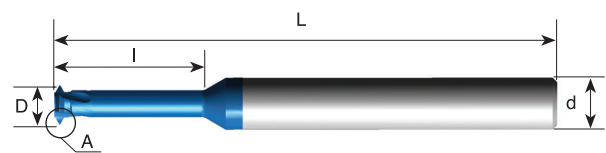
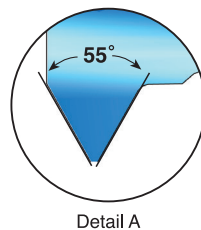

Grade	P	M	K	N	S	H
MT11	●	●	●	○	●	≤62 HRc

Pitch TPI	Ordering Code	d	D	No. of Flutes	I	L
40-32	MTI 03023 C7 A55	3	2.25	3	7.0	39
28-20	MTI 06044 C14 A55	6	4.35	3	14.0	58
28-18	MTI 06059 C20 A55	6	5.85	3	20.5	58
20-14	MTI 0807 C23 A55	8	7.00	3	23.0	64

Order example: MTI 03023 C7 A55 MT11

● First choice ○ Alternative

ISO

Tools for Internal Thread

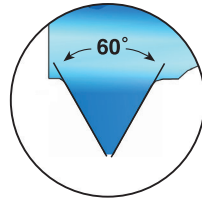

Detail A

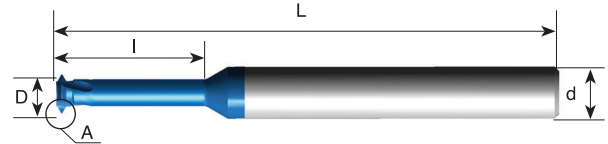

Grade	P	M	K	N	S	H
MT11	●	●	●	○	●	≤62 HRc

Pitch mm	M Coarse	M Fine	Ordering Code	d	D	No. of Flutes	I	L	Thread depth
0.25	M1		MTI 03007 C3 0.25 ISO	3	0.72	3	3.6	39	3.5xD1
0.25	M1.2	M1.4 M1.6	MTI 03009 C4 0.25 ISO	3	0.90	3	4.3	39	3.5xD1
0.3	M1.4		MTI 03011 C5 0.3 ISO	3	1.05	3	5.0	39	3.5xD1
0.35	M1.6	M2 M2.2	MTI 03012 C6 0.35 ISO	3	1.20	3	5.7	39	3.5xD1
0.4	M2		MTI 03016 C7 0.4 ISO	3	1.55	3	7.1	39	3.5xD1
0.45	M2.5		MTI 0302 C8 0.45 ISO	3	1.95	3	8.8	39	3.5xD1
0.5	M3	M3.5 M4	MTI 03024 C10 0.5 ISO	3	2.37	3	10.6	39	3.5xD1
0.7	M4		MTI 04032 D14 0.7 ISO	4	3.20	4	14.0	50	3.5xD1

Order example: MTI 03012 C6 0.35 ISO MT11

UN

Tools for Internal Thread

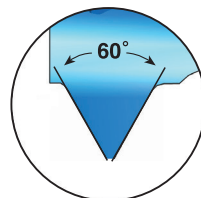

Detail A

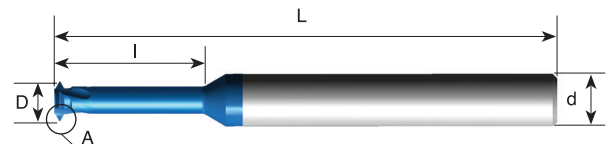

Grade	P	M	K	N	S	H
MT11	●	●	●	○	●	≤62 HRc

Pitch TPI	UNC	UNF	Ordering Code	d	D	No. of Flutes	I	L	Thread depth
80		0	MTI 03012 C5 80 UN	3	1.15	3	5.5	39	3.5xD1
72		1	MTI 03015 C7 72 UN	3	1.45	3	6.6	39	3.5xD1
56	2	3	MTI 03016 C9 56 UN	3	1.65	3	8.9	39	3.5xD1
40	4		MTI 03021 C10 40 UN	3	2.10	3	10.1	39	3.5xD1

Order example: MTI 03016 C9 56 UN MT11

● First choice

○ Alternative

Trapez-DIN 103

Tools for Internal Thread

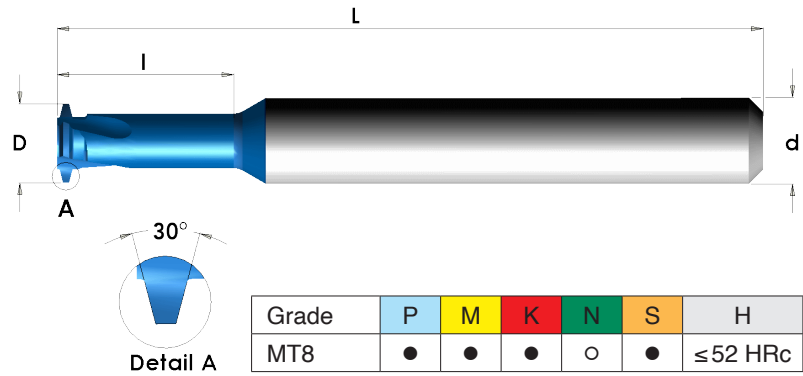

Grade	P	M	K	N	S	H
MT8	●	●	●	○	●	≤52 HRc

Pitch mm	Thread size	Ordering Code	d	D	No. of Flutes	I	L	Thread Depth
1.5	Tr8x1.5 Tr9x1.5	MTI 06055 C13 1.5 TR	6	5.5	3	13.5	58	2xD1
2	Tr10x2 Tr11x2	MTI 08066 C21 2 TR	8	6.6	3	21.0	64	2xD1
2	Tr12x2 Tr14x2	MTI 10086 D25 2 TR	10	8.6	4	25.0	73	2xD1
3	Tr12x3	MTI 0807 C25 3 TR	8	7.0	3	25.0	64	2xD1
3	Tr14x3 Tr22x3	MTI 10089 D29 3 TR	10	8.9	4	29.0	73	2xD1
4	Tr16x4 Tr18x4 Tr20x4	MTI 10092 C33 4 TR	10	9.2	3	33.0	73	2xD1
5	Tr22x5 Tr24x5 Tr26x5	MTI 14135 D45 5 TR	14	13.5	4	45.0	105	2xD1

Order example: MTI 08066 C21 2 TR MT8

Acme

Tools for Internal Thread

Inch Shank

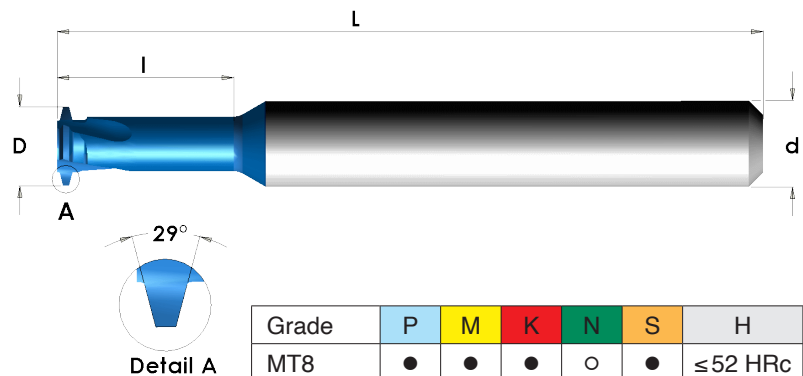

Grade	P	M	K	N	S	H
MT8	●	●	●	○	●	≤52 HRc

Pitch TPI	Thread size	Ordering Code	d	D	No. of Flutes	I	L	Thread Depth
16	1/4-16	MTI 0250 C04 16 ACME	1/4	4.3	3	9.7	64	1.5xD1
14	5/16-14	MTI 0250 C06 14 ACME	1/4	5.2	3	15.2	64	2xD1
12	3/8-12 7/16-12	MTI 0250 C08 12 ACME	1/4	6.1	3	19.1	64	2xD1
10	1/2-10	MTI 0375 D10 10 ACME	3/8	8.3	4	25.4	76	2xD1
8	5/8-8	MTI 0500 D11 8 ACME	1/2	10.4	4	27.9	89	1.5xD1
6	3/4-6 7/8-6	MTI 0500 D12 6 ACME	1/2	12.0	4	30.5	89	1.5xD1
5	1-5 1 1/8-5 1 1/4-5	MTI 0625 E15 5 ACME	5/8	15.9	5	38.1	102	1.5xD1

Order example: MTI 0375 D10 10 ACME MT8

● First choice ○ Alternative

FMTI Multi Flute

CPT has designed a unique line of solid carbide thread milling tools FMTI for increased productivity and high performance.

Large number of flutes enables to achieve significant shorter machining time.

Carbide grade: MT6

Ultra-Fine carbide grade with high hardness and toughness provides an excellent solution for machining steels, stainless steels, and super alloys Ni or Ti base. With a universal PVD multi-layer coating, provides high heat and wear resistance.

ISO

Tools for Internal Thread

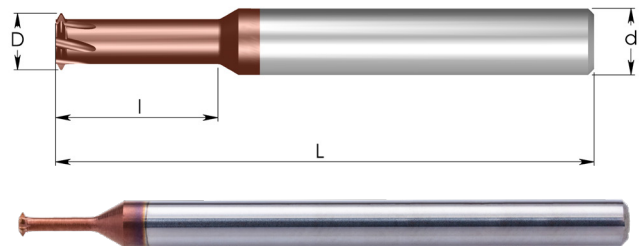

Grade	P	M	K	N	S	H
MT6	●	●	○	○	●	≤58 HRc

Pitch mm	M Coarse	M Fine	Ordering Code	d	D	No. of Flutes	I	L	Thread Depth
0.35	M1.6, M1.8	M2	FMTI 03012 E3 0.35 ISO	3	1.20	5	3.6	38	2xD1
0.4	M2		FMTI 03016 F4 0.4 ISO	3	1.55	6	4.4	38	2xD1
0.45	M2.5		FMTI 0302 F5 0.45 ISO	3	1.95	6	5.5	38	2xD1
0.5	M3	M4, M5	FMTI 03024 F6 0.5 ISO	3	2.40	6	6.5	38	2xD1
0.7	M4		FMTI 04032 F8 0.7 ISO	4	3.20	6	8.7	50	2xD1
0.8	M5		FMTI 0404 G10 0.8 ISO	4	4.00	7	10.8	50	2xD1
1.0	M6	M8	FMTI 06048 G13 1.0 ISO	6	4.80	7	13.0	57	2xD1

Order example: FMTI 03024 F6 0.5 ISO MT6

UN

Tools for Internal Thread

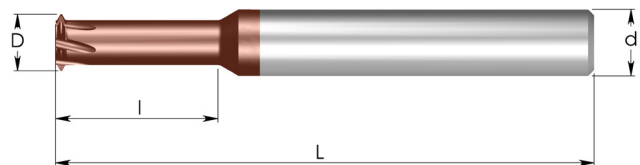

Grade	P	M	K	N	S	H
MT6	●	●	○	○	●	≤58 HRc

Pitch TPI	UNC	UNF	Ordering Code	d	D	No. of Flutes	I	L	Thread Depth
72		1	FMTI 03015 E4 72 UN	3	1.45	5	4.1	38	2xD1
56	2	3	FMTI 03017 F4 56 UN	3	1.65	6	4.8	38	2xD1
40	4		FMTI 03021 F6 40 UN	3	2.10	6	6.3	38	2xD1
32		10	FMTI 04038 F10 32 UN	4	3.80	6	10.5	50	2xD1
28		1/4	FMTI 06052 G13 28 UN	6	5.20	7	13.6	57	2xD1

Order example: FMTI 03017 F4 56 UN MT6

● First choice

○ Alternative